

MHLS LED

Stainless steel LED lighting
for hazardous locations

**RIG-A-LITE™**
An Avail Infrastructure Solutions Company

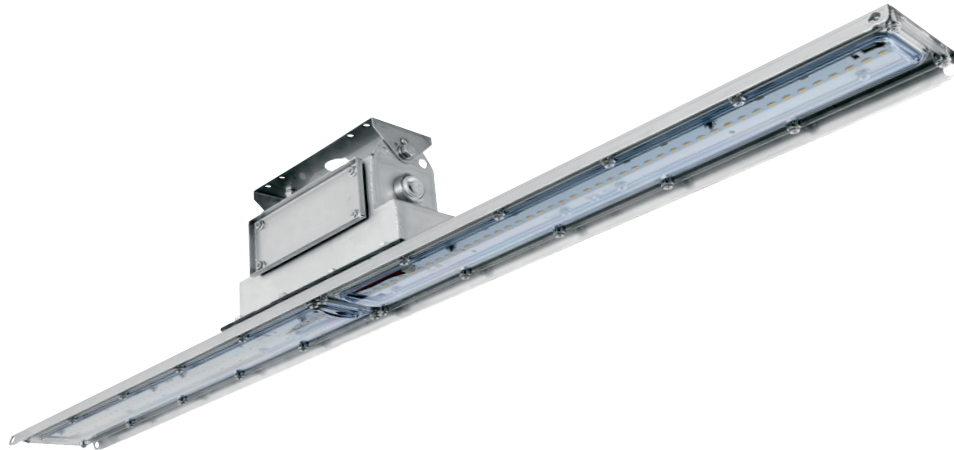

Classifications

- Class I, Division 2, Groups A, B, C & D
- Class II, Division 2, Groups F & G
- Class III
- Class I, Zone 2, Groups IIA, IIB, IIC, Zone 22 (ANSI/UL 844)
- UL 1598A Marine Outside Type
- UL 1598 Wet Locations
- UL 8750 LED Safety
- UL 844 Hazardous Locations
- UL 924 Emergency Lighting
- CSA C22.2 No. 250.0-08
- CSA C22.2 No. 137-M1981
- NEMA 4X
- IP66
- Buy American Act (BAA) Compliant



availinfra.com/rig-a-lite

8500 Hansen Road
Houston, TX 77075
(713) 943-0340

MHLS LED

Stainless steel LED lighting for hazardous locations

Key Features

- 1 Low-profile, lightweight design
- 2 Integral safety cable attachment points
- 3 Toolless, cage-clamp terminal block
- 4 Captive junction box cover, attached by nylon-coated stainless steel cable
- 5 Field replaceable LED circuit boards and drivers with quick disconnects
- 6 Adjustable mounting bracket with 60° range of motion and nine locking positions*
- 7 Impact resistant clear lens

* Not included, must be ordered separately.
Please see options section.

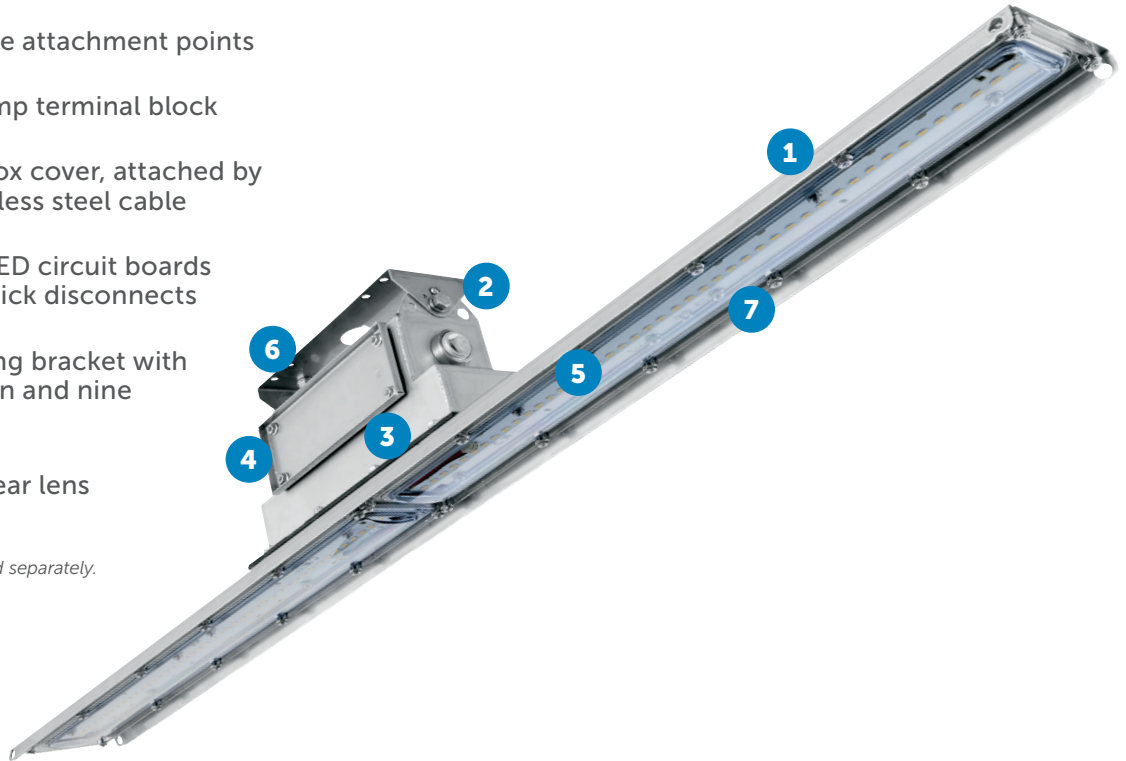

Additional Features

- Central safety cable attachment points for increased safety/reduced range of motion
- Feed-through capable
- Optional end brackets for chain mount applications
- Emergency battery back-up
- Diffused lens option
- Standard 10kV surge protection
- 5-year warranty

Standard Materials

- Body:**
Type 316 stainless steel
- Driver Body:**
Type 316 stainless steel
- Gaskets:**
One-piece Neoprene
- Optional End Brackets:**
Stainless Steel
- Lens:**
Polycarbonate
- Hardware:**
Stainless Steel

MHLS LED

Stainless steel LED lighting for hazardous locations

Catalog Number Logic

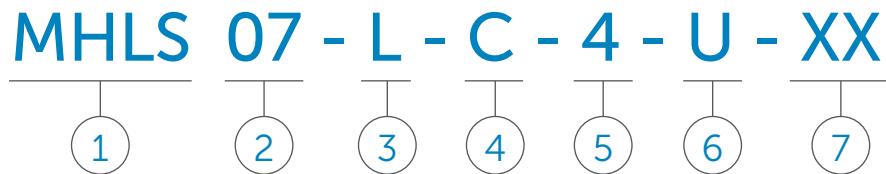

1
SERIES
MHLS LED¹

2
LAMP WATTAGE
04 = 27 Watt (2 foot)
05 = 37 Watt (2 foot)
06 = 39 Watt (2 foot)
07 = 52 Watt (4 foot)
09 = 72 Watt (4 foot)
11 = 77 Watt (4 foot)

3
LAMP TYPE
L = LED (4000K CCT)

4
LENS
C = Clear
D = Diffused

5
NOMINAL FIXTURE LENGTH
2 = 2 Foot
4 = 4 Foot

6
VOLTAGE/FREQUENCY
U = 120 - 277V 50/60HZ
A = 120V 60HZ²
B = 220 - 240V 50/60HZ²
C = 277V 60HZ²

7
OPTIONS
RIG = Mounting Bracket & (2) Safety Cables
MB = Mounting Bracket Ceiling or Wall
EB = End Brackets Cable or Chain Suspension
EM = Emergency Battery Backup
FB = Fuse Block
SC = Safety Cable
30 = 3000K CCT
35 = 3500K CCT
50 = 5000K CCT

¹ Mounting Hardware not included. Please see options for mounting selections.

² Specify voltage when option FB is needed. When option FB is selected, one fuse is provided for 120 and 277V. Two fuses are provided for 220-240V. Fuse option not available for marine listed fixtures, or for fixtures listed for use in Canada.

Catalog logic is for explaining catalog number structure only. Not all combinations are possible; consult factory for catalog numbers not listed in charts.

Certification Guide

Model	Length	Watts	Operating Voltage	Total Lumens	Lumen per Watt	CRI	CCT	Ambient Temperature	Class I, Div. 2, Group A, B, C & D	Class II, Div. 2 Group F & G Class III	Simultaneous Presence	Supply Wire Suitable Temp., °C
MHLS04LC2	2 ft	27W	120V - 277V 50/60 Hz, 347V/480V 60Hz	3620	134	83	4069	-40°C < Tamb < 55°C	T4A	T4A	T4A	90°C
MHLS05LC2	2 ft	37W		4833	130	83	4089	-40°C < Tamb < 55°C	T4A	T4A	T4A	90°C
MHLS06LC2	2 ft	39W		5550	142	83	4072	-40°C < Tamb < 50°C	T4	T4	T4	90°C
MHLS07LC4	4 ft	52W		7261	140	83	4105	-35°C < Tamb < 60°C	T4A	T4A	T4A	90°C
MHLS09LC4	4 ft	72W		9757	136	83	4123	-35°C < Tamb < 60°C	T4A	T4A	T4A	90°C
MHLS11LC4	4 ft	77W		11252	147	83	4071	-35°C < Tamb < 50°C	T4	T4	T4	90°C

MHLS LED

Stainless steel LED lighting for hazardous locations

Candlepower Distribution

MHLS04LC2UXX

Deg.	0.	30	60	90
0	1321.4	1321.4	1321.4	1321.4
10	1297.5	1294	1295.4	1295.5
20	1236.2	1235.2	1229.6	1238.6
30	1124.4	1124.5	1125.2	1135.7
40	979.7	980.6	981.8	989.3
50	776.3	780.1	787.2	799.2
60	547	535.7	529.1	527.1
70	275.6	263.3	277.6	319.5
80	56.7	52	2.1	0.7
90	1.9	0.1	0	0

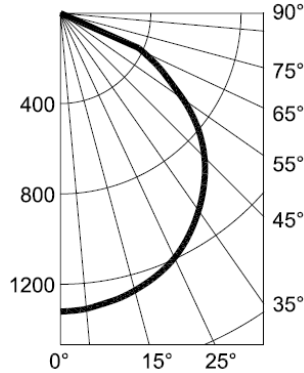

MHLS05LC2UXX

Deg.	0.	30	60	90
0	1755.9	1755.9	1755.9	1755.9
10	1724.1	1719.5	1721.3	1721.4
20	1642.7	1641.3	1633.8	1645.8
30	1494	1494.1	1495.2	1509
40	1301.8	1303	1304.5	1314.5
50	1031.5	1036.6	1046	1062
60	726.8	711.8	703	700.4
70	366.3	349.8	368.9	424.5
80	75.4	69.1	2.8	1
90	2.6	0.1	0	0

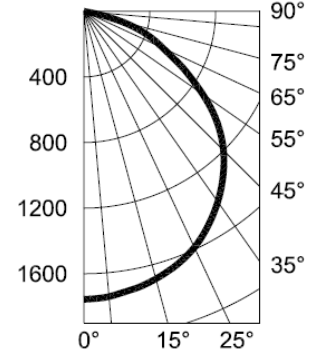

MHLS06LC2UXX

Deg.	0.	30	60	90
0	2041	2041	2041	2041
10	2002.6	2003.5	2017.9	2018.2
20	1907	1914.5	1904.1	1907.3
30	1745.6	1748	1747.3	1752.4
40	1536.9	1523.9	1521.8	1498
50	1213.2	1220.4	1167.1	1172.1
60	862.8	835.7	820.1	832.5
70	455.4	430.4	461.2	266.8
80	99.3	72.5	12.7	9.7
90	3.3	.2	0	0

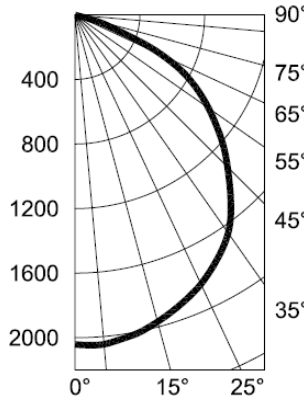

MHLS07LC4UXX

Deg.	0.	30	60	90
0	2989.1	2989.1	2989.1	2989.1
10	2979.4	3013.9	2951.2	2979.6
20	2999.6	2967.6	2820.4	2826.5
30	2923.4	2865.5	2626.8	2564.9
40	2541	2541	2155.9	2022.5
50	1619.1	1379.1	1133.3	1229.3
60	749.5	634.4	505.6	571
70	312.2	375.6	298.5	242.6
80	97.3	209.5	110	89.4
90	11.3	55.1	41.2	36.1

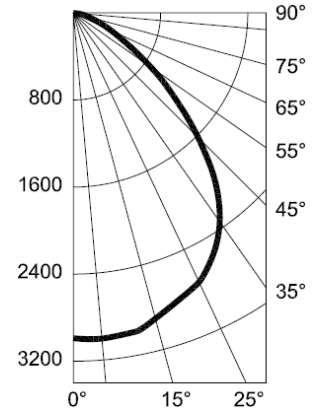

MHLS09LC4UXX

Deg.	0.	30	60	90
0	3138.7	3138.7	3138.7	3138.7
10	3128.3	3131.2	3108.2	3095.3
20	3149.8	3106.8	2980.3	2967.7
30	3100.4	3046	2789.6	2705.1
40	2989.1	2920	2461	2350.4
50	2542.8	2489.4	2021.1	1906
60	1836.4	1791.3	1415.9	1309.8
70	993.9	949.7	799.2	783.2
80	253.9	216.9	29.4	18.4
90	8	2.8	0.2	0.2

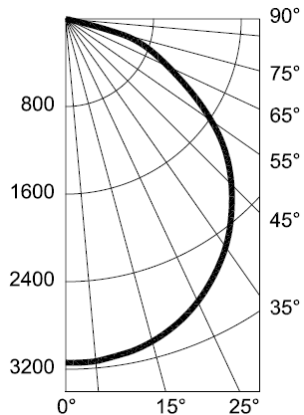

MHLS11LC4UXX

Deg.	0.	30	60	90
0	3617.3	3617.3	3617.3	3617.3
10	3611.3	3605.4	3571.7	3560.9
20	3624.8	3570.6	3424.7	3403.1
30	3635.8	3500.5	3207.1	3118.6
40	3520.1	3349.1	2872.5	2727.7
50	2936.8	2869	2348.2	2205.4
60	2160.3	2072.4	1675.7	1567.1
70	1152.5	1111.5	1005.1	722.6
80	281.6	216.3	23	17.2
90	11.3	4.8	0.3	0.2

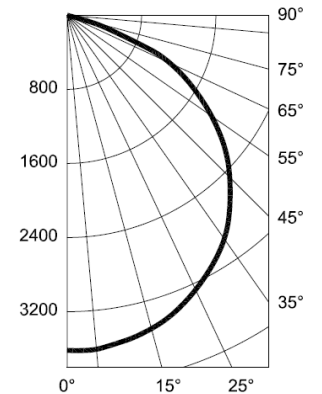

MHLS LED

Stainless steel LED lighting for hazardous locations

Fixture Dimensions (inches)

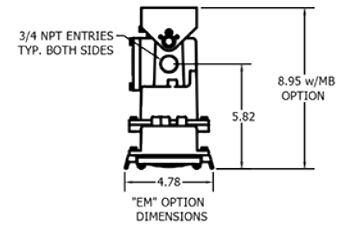
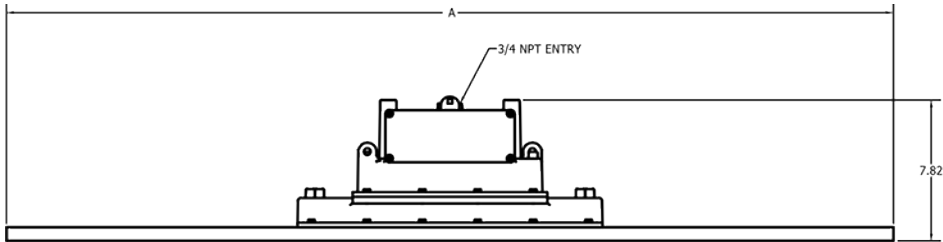
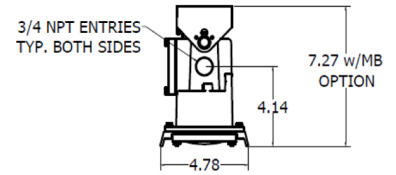
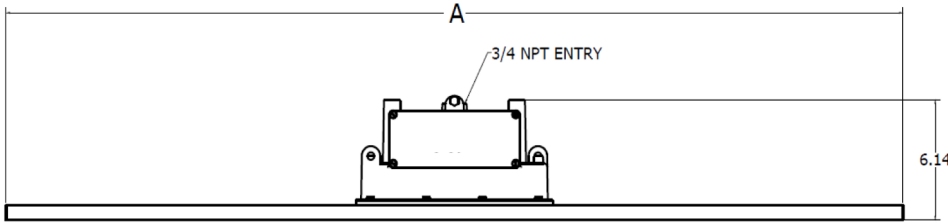

"EM" OPTION DIMENSIONS

"EM" OPTION DIMENSIONS

Nominal Fixture Length	Dimensions (inches)		Boxed Weight	Shipping Volume (Boxed Fixture)
	A			
4 ft. Models	48.00		18 lbs.	1.47 cu. ft.
2 ft. Models	24.00		10 lbs.	.76 cu. ft.

MHLS LED

Stainless steel LED lighting for hazardous locations

Accessories

Mounting Bracket

Ceiling or Wall

Catalog Number:
53052

Shipping Weight:
2 lbs.

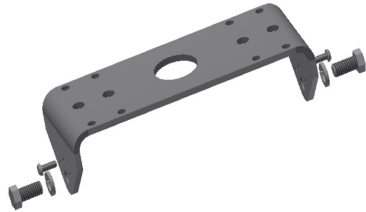

End Brackets

Cables or Chain

Catalog Number:
53051

Shipping Weight:
1 lb.



Beam Clamp

Catalog Number:
38083

Shipping Weight:
1.25 lbs.



Beam Clamp Mounting Kit

Catalog Number:
53010

Shipping Weight:
3 lbs.



Safety Cable

Catalog Number:
10128R

Shipping Weight:
1 lb.



An Avail Infrastructure Solutions Company

availinfra.com/rig-a-lite

8500 Hansen Road
Houston, TX 77075
(713) 943-0340