

# EHW LED

Hazardous-rated LED wallpack linear lighting for challenging environments

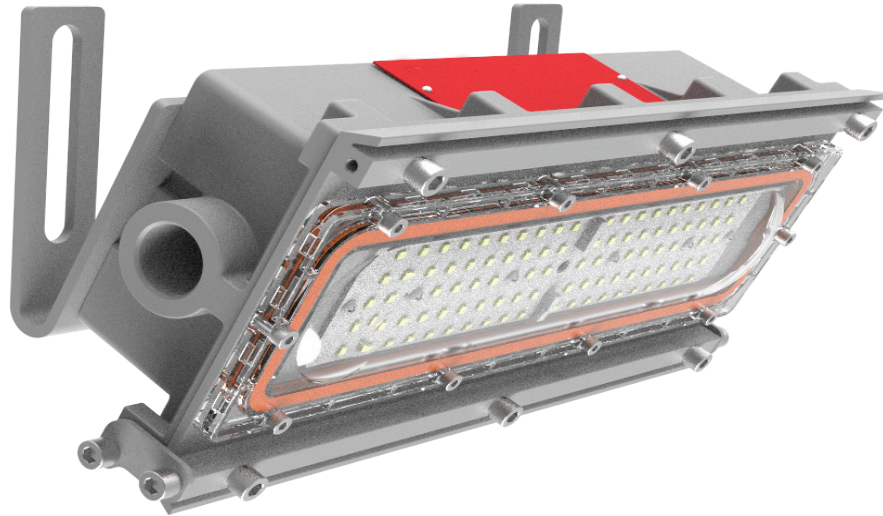

## E-SERIES

### Cost-effective, energy-efficient lighting for demanding environments

The RIG-A-LITE E-Series provides economical lighting solutions for industrial and hazardous applications, offering reliable performance and durability.

#### Classifications

- Class I, Division 2, Groups A, B, C, & D
- Class II, Division 1 & 2, Groups E, F & G
- Class III
- Class I, Zone 2, Group IIC
- Zone 21, Zone 22
- UL 844 Hazardous Locations
- UL 1598 Wet Locations
- UL 1598A Marine Outside Type
- UL 8750 LED Safety
- CSA C22.2 No. 137-M1981
- CSA C22.2 No. 250.0
- NEMA 4X
- IP67
- IK10
- 5G
- Resistant up to 2,000 PSI hose directed water
- Tested to 1000 hrs salt spray to standard ASTM "B117-11"



[availinfra.com/rig-a-lite](http://availinfra.com/rig-a-lite)

8500 Hansen Road  
Houston, TX 77075  
(713) 943-0340

# EHW LED

## Hazardous-rated LED wallpack linear lighting for challenging environments

### Key Features

- 1 Slim Profile & Lighter** - Less than 100mm fixture height, perfect for mounting in confined or low height areas
- 2 Rugged Heat Sink** - Superior thermal design provides cool operation from -40°C to +65°C (-40°F to +149°F)
- 3 High Efficiency** - Delivers up to 165lm/W and 4,950 lumens reducing energy costs by up to 75% over conventional lamps
- 4 Impact-Resistant PC Lens** - UV polycarbonate lens passed IK09 test for extreme durability
- 5 Quick & Easy Installation** - Clamshell design easy access to drivers and multiple entries standard for easy through wiring

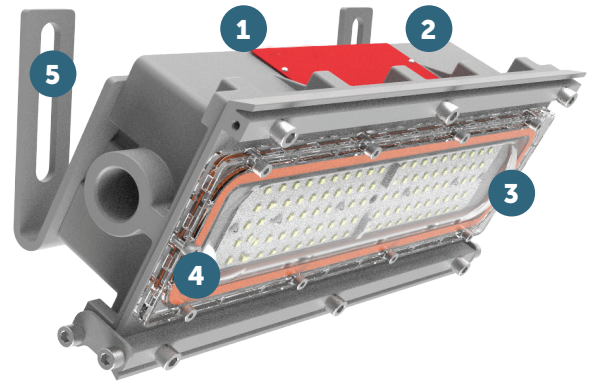

### Additional Features

- Universal voltage: AC120-277, 347-480V (50/60Hz)
- High efficacy up to 165lm/W
- CCT Adjustable (3000K/4000K/5000K)
- Wildlife-friendly amber color options
- 10kV surge protector is standard, 20kV optional
- Dimming: Standard 1-10VDC
- Ambient operating temperature -40°C to 65°C
- Lumen maintenance L70 > 150,000 hours @ 25°C
- 5-year warranty

### Standard Materials

#### Body:

Housing, splice box, and adapter are die-cast copper-free aluminum with baked powder epoxy/polyester finish

#### Gaskets:

High temperature resistant silicone

#### Lens:

Heat, shock, impact, and UV resistant polycarbonate

#### Hardware:

Stainless Steel with lacquer-free nameplate

# EHW LED

Hazardous-rated LED wallpack linear lighting for challenging environments

## Catalog Number Logic

EHW 3 - U - 2 - 110 - WW - TPL - FSM - GR - XX

1

2

3

4

5

6

7

8

9

10

### 1

#### BASIC LUMINAIRE

EHW = N. American Standards

### 2

#### LUMENS/WATTS

03 = 3,300 Lumens / 20 Watts

05 = 4,950 Lumens / 30 Watts

### 3

#### VOLTAGE

U = 100-277V

### 4

#### PROTECTION LEVEL

2 = C1D2, C2D1

### 5

#### OPTICS

110 = 110° Beam Angle

### 6

#### COLOR TEMPERATURE

WW = 2700K (Warm white)

SW = 3000K (Soft white)

NW = 4000K (Neutral white)

CW = 5000K (Cool white)

AM = Amber

AJC = Adjustable CCT  
(3000K/4000K/5000K)

### 7

#### LENS

TPL = Transparent Polycarbonate

FPL = Frosted Polycarbonate

### 8

#### MOUNTING STYLE

FLM = Flush ceiling/wall mount

OSM = Offset ceiling/wall  
swivel bracket

PCM48 = Pole clamp 48mm for  
pole 1-7/8"

PCM60 = Pole clamp 60mm for  
pole 2-3/8"

WB25 = Wall bracket 25°

### 9

#### COLOR

GR = Gray

### 10

#### OPTIONS

SC2 = Safety cable

VS3 = Dark sky visor

SP10U = 10KV surge protector  
(100-277V) \* Standard

SP20U = 20KV surge protector (100-277V)

CAB = 3' SEOOW-18/3 cord

CGL = Cable gland 3/4" NPT

# EHW LED

Hazardous-rated LED wallpack linear lighting for challenging environments

## Certification Guide

Model	Watts	Operating Voltage	Total Lumens <sup>1</sup>	Lumens per Watt <sup>1</sup>	CRI <sup>1</sup>	CCT <sup>1</sup>	Ambient Temperature <sup>1</sup>	Class I, Div. 2, Group A, B, C & D	Class II, Div. 1, Group E, F, G, Class III	Supply Wire Suitable Temperature, °C
EHW03	20W	100-277V 50/60HZ	3300	165.0	70	4000K	-40°C < Tamb < 65°C	T4A	T5	90°C
EHW05	30W	100-277V 50/60HZ	4950	165.0	70	4000K	-40°C < Tamb < 65°C	T4A	T5	90°C

1. When TPL option is selected, total lumens, lumens per watt, CRI, CCT or ambient temperature may change. Consult factory for values.

# EHW LED

Hazardous-rated LED wallpack linear lighting for challenging environments

## Photometric Data

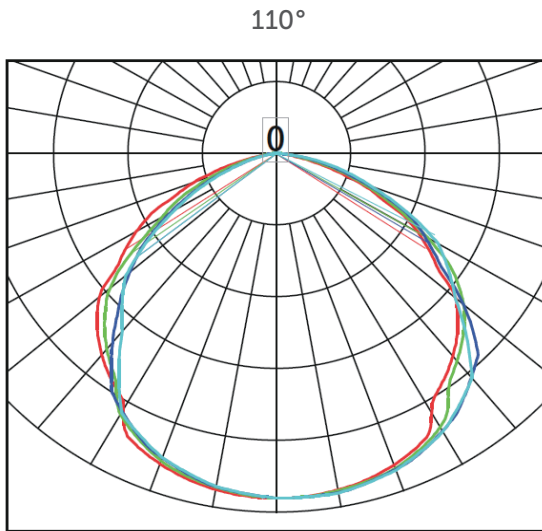

# EHW LED

Hazardous-rated LED wallpack linear lighting for challenging environments

## Mounting Options

### 25° Wall Swivel Bracket: WB25

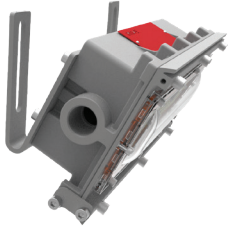

Fixture	Weight
EHW03	6.46 lbs.
EHW05	6.46 lbs.

### Flush Mount: FLM

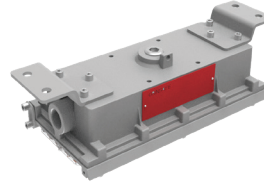

Fixture	Weight
EHW03	7.28 lbs.
EHW05	7.28 lbs.

### Offset Ceiling/Wall Swivel Bracket: OSM

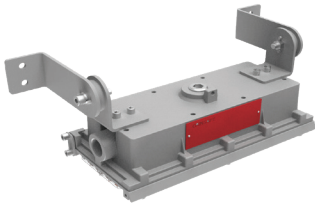

Fixture	Weight
EHW03	8.16 lbs.
EHW05	8.16 lbs.

### Pole Clamp Mount: PCM

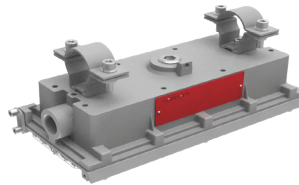











Fixture	Weight
EHW03	6.77 lbs.
EHW05	6.77 lbs.

# EHW LED

Hazardous-rated LED wallpack linear lighting for challenging environments

## Accessories

	Catalog No.	Size (in.)	Shipping Weight (lbs.)
<b>Wall Bracket Mount Kit</b> 	WB25 (1 pair)	4.49" x 2.48" x 1.18"	0.51 lbs.
<b>Flush Mount Kit</b> 	FLM (1 pair)	3.74" x 3.15" x 0.95"	1.32 lbs.
<b>Stainless Steel Safety Cable</b> 	SC1	39.4"	0.29 lbs.
<b>Stainless Steel Dark Sky Visor</b> 	VS3	12.02" x 3.15" x 1.97"	0.37 lbs.
<b>Offset Ceiling/Wall Swivel Bracket</b> 	OSM	5.24" x 4.49" x 2.20"	2.20 lbs.
<b>Pole Clamp Mount Kit</b> 	PBM (1 pair)	3.62" x 2.36" x 1.3"	0.82 lbs.

	Catalog No.	Size (in.)	Shipping Weight (lbs.)
<b>3' SEOWW-18/3 Cord</b> 	CAB	39.4"	0.21 lbs.
<b>Cable Gland</b> 	CGL	1.46" x 1.73"	0.06 lbs.
<b>10KV Surge Protector</b>  * Standard	SP10U 10KV (100-277V)	4.18" x 0.91" x 0.51" Without Wire	0.09 lbs.
	SP10N 10KV (347-480V)	4.33" x 0.99" x 0.71" Without Wire	0.11 lbs.
<b>20KV Surge Protector</b> 	SP20U 20KV (100-277V)	4.41" x 1.1" x 0.59" Without Wire	0.12 lbs.
	SP20N 20KV (347-480V)	4.33" x 1.18" x 0.71" Without Wire	0.15 lbs.



An Avail Infrastructure Solutions Company

[availinfra.com/rig-a-lite](http://availinfra.com/rig-a-lite)

8500 Hansen Road  
Houston, TX 77075  
(713) 943-0340