

# FPF SERIES

## Non-Metallic Fixture for Food Processing

- UL 924 Emergency Lighting
- UL 1598 Wet Locations
- CUL
- NSF Certified Food Equipment
- High Pressure Hose Down



713.943.0340 | [azz.com/rigalite](http://azz.com/rigalite)

# FPF SERIES

## Non-Metallic Fixture for Food Processing

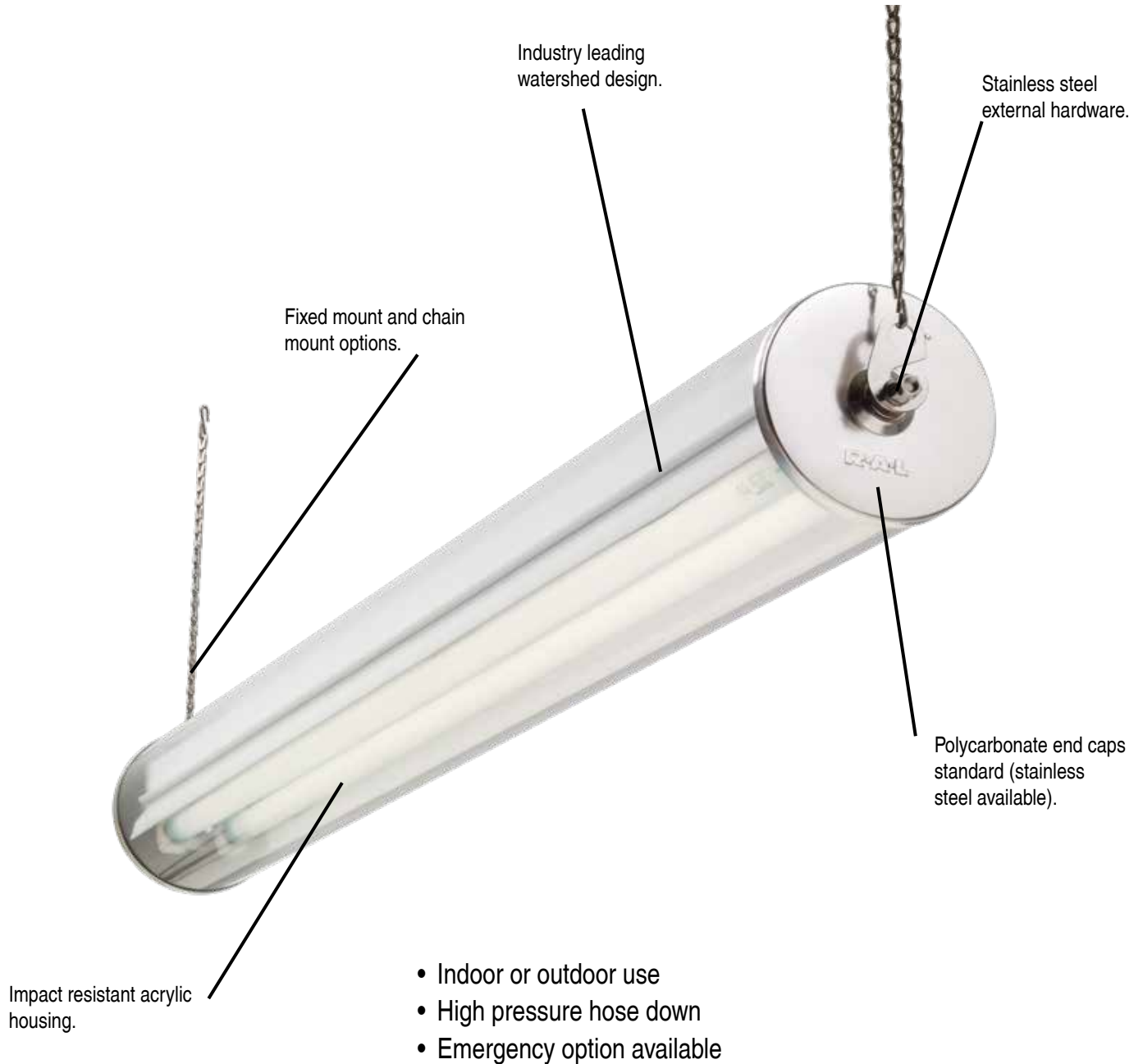

# FLUORESCENT FPF Series

Non-Metallic Housing • UL 1598 • CUL • Wet Locations • High Pressure Hose Down • Indoor or Outdoor • NSF Certified

## Catalog Number Logic

# FPF 800-8-4-U-XX

1

2

3

4

5

6

1

### BASIC SERIES<sup>1</sup>

FPF Non-Metallic Fluorescent Fixture  
UL 1598 Wet Locations  
CUL  
NSF Certified Food Equipment

2

### LAMP CURRENT/LAMP WATTAGE

800 = 800mA, 110, 60 or 35 Watt  
430 = 430mA, 34 or 20 Watt (export only)  
425 = 425mA, 75, 40 or 20 Watt (Slimline)  
265 = 265mA, 59, 32 or 17 Watt (T8 Lamps)  
T5HO = T5HO, 54 Watt

3

### NOMINAL FIXTURE LENGTH

2 = 2 Foot (T5 & T5HO Consult Factory)  
4 = 4 Foot  
8 = 8 Foot

4

### NUMBER OF LAMPS

2 = 2 Lamp  
3 = 3 Lamp (4 ft. T5HO Only)  
4 = 4 Lamp (8 ft. Only)  
6 = 6 Lamp (8 ft. T5HO Only)  
Not Available as Emergency

5

### VOLTAGE/FREQUENCY

A = 120V 60 HZ (430 mA Emergency Only)  
B = 236V 60 HZ (430 mA Emergency Only)  
C = 277V 60 HZ (430 mA Emergency Only)  
D = 220V 50 HZ  
E = 12V DC  
F = 24V DC  
G = 32V DC  
H = 347V 60 HZ  
U = 120 thru 277V 50/60 HZ

6

### OPTIONS<sup>2</sup>

F = Single Fuse  
HL = Hi-Lumen Ballast (T8 Only)  
L = Lamps  
LC = Coated Lamps  
R = Radio Interference Filter  
SS = Stainless Steel End Caps  
EON = Emergency Only  
ENN = Emergency & Normal Operation  
ENS = Emergency & Normal Switched  
1UP = 2 lamps down and 1 lamp up

<sup>1</sup> Fixtures are furnished with PPFMKT1 standard, non-metallic cord grip and 3 ft. long #16, AWG 3 conductor type SOA cable.

<sup>2</sup> Consult factory for pricing.

# FLUORESCENT FPF Series

Non-Metallic Housing • UL 1598 • CUL • Wet Locations • High Pressure Hose Down • Indoor or Outdoor • NSF Certified

## Fluorescent Series



- UL 1598 Wet Locations
- CUL
- NSF Certified Food Equipment
- Non-metallic housing
- Aluminum reflector and ballast cover
- External stainless steel hardware
- Suitable for high pressure hose down
- Suitable for indoor or outdoor
- Optional stainless steel end caps available

## Fluorescent Emergency Series



- Emergency illumination meets OSHA, Life Safety Code (NFPA 101), and National Electric Code (NFPA 70) requirements
- Switched or non-switched applications
- Provides 1100-1200 lumens of initial light output in emergency mode
- Provides at least 90 minutes of illumination in emergency mode
- Sealed, maintenance-free nickel cadmium batteries with a life expectancy of 7-10 years
- Self Contained unitized construction
- Easily identified as an emergency lighting fixture
- Charging indicator LED pilot light
- Battery cut-off switch is standard
- NSF Certified Food Equipment

With emergency option, red polycarbonate endcaps are furnished.

For fixtures with stainless steel endcaps, emergency labels are installed on each side in the center, clearly visible through the acrylic housing.

# FLUORESCENT FPF Series

Non-Metallic Housing • UL 1598 • CUL • Wet Locations • High Pressure Hose Down • Indoor or Outdoor • NSF Certified

## Fluorescent Series

(Lamps not included)

	Description	Voltage	Catalog Number
<b>Two Foot Fixture</b>	20 Watt, Preheat, Trigger Start Medium Bi-Pin, T12 430mA Lamps, 24" (export only)	120-277V 50/60 HZ	<b>FPF430-2-2L-U</b>
	17 Watt, Instant Start Medium Bi-Pin, T8 265mA Lamps, 24"	120-277V 50/60 HZ	<b>FPF265-2-2L-U</b>
<b>Four Foot Fixture</b>	34 Watt, Rapid Start Medium Bi-Pin, T12 430mA Lamps, 48" (export only)	277V/60 HZ	<b>FPF430-4-2L-U</b>
	32 Watt, Instant Start Medium Bi-Pin, T8 265mA Lamps, 48"	120-277V 50/60 HZ	<b>FPF265-4-2L-U</b>
	40 Watt, Instant Start, Slimline T12, Single Pin, 425mA Lamps, 48"	12V DC	<b>FPF425-4-2L-E</b>
		24V DC	<b>FPF425-4-2L-F</b>
		32V DC	<b>FPF425-4-2L-G</b>
	54 Watt, T5HO Miniature Bi-Pin, 48"	120-277V 50/60 HZ	<b>FPFT5HO-4-2L-U</b> <b>FPFT5HO-4-3L-U</b>
60 Watt, Rapid Start, High Output T12, Recessed Double Contact 800mA Lamps, 48"	120-277V 50/60 HZ	<b>FPF800-4-2L-U</b>	
<b>Eight Foot Fixture</b>	32 Watt, Instant Start Medium Bi-Pin, T8 265mA Lamps, 48"	120-277V 50/60 HZ	<b>FPF265-8-4L-U</b>
	54 Watt, T5HO Miniature Bi-Pin 48"	120-277V 50/60 HZ	<b>FPFT5HO-8-4L-U</b>
			<b>FPFT5HO-8-6L-U</b>
	59 Watt, Rapid Start Slimline, T8 Single Pin 265mA Lamps, 96"	120-277V 50/60 HZ	<b>FPF265-8-2L-U</b>
	75 Watt, Instant Start Slimline, T12, Single Pin 425mA Lamps, 96"	12V DC	<b>FPF425-8-2L-E</b>
		24V DC	<b>FPF425-8-2L-F</b>
32V DC		<b>FPF425-8-2L-G</b>	
110 Watt, Rapid Start, High Output T12, Recessed Double Contact 800mA Lamps, 96"	120-277V 50/60 HZ	<b>FPF800-8-2L-U</b>	

Fixtures are furnished with stainless steel chain mount kit, non-metallic cord grip and 3 ft. long #16 AWG 3 conductor type SOA cable.

# FLUORESCENT FPF Series

Non-Metallic Housing • UL 1598 • CUL • Wet Locations • High Pressure Hose Down • Indoor or Outdoor • NSF Certified

## Fluorescent Emergency Series

(Lamps not included)

Fixture Type	Circuit Type	Nominal Fixture Length	Description	Voltage	Catalog Number
Emergency Only Operation	Non-Switched <sup>①</sup>	Two Foot 2 Lamp Fixture	20 Watt, Preheat, Trigger Start Medium B-Pin, T12 430mA Lamps, 24" (export only)	120-277V 50/60 HZ	FPF430-2-2L-U-EON
			17 Watt, Instant Start, Medium Bi-Pin, T8 265mA Lamps, 24"	120-277V 50/60 HZ	FPF265-2-2L-U-EON
		Four Foot 2 Lamp Fixture	34 Watt, Rapid Start Medium Bi-Pin, T12 430mA Lamps, 48" (export only)	120--277V 50/60 HZ	FPF430-4-2L-U-EON
			32 Watt, Instant Start, Medium Bi-Pin, T8 265mA Lamps, 48"	120-277V 50/60 HZ	FPF265-4-2L-U-EON
			60 Watt, Rapid Start, High Output T12, Recessed Double Contact 800mA Lamps, 48"	120-277V 50/60 HZ	FPF800-4-2L-U-EON
Emergency and Normal Operation	Non-Switched <sup>①</sup>	Four Foot 2 Lamp Fixture	34 Watt, Rapid Start Medium Bi-Pin, T12 430mA Lamps, 48" (export only)	120-277V/ 5060 HZ	FPF430-4-2L-U-ENN
			32 Watt, Instant Start, Medium Bi-Pin, T8 265mA Lamps, 48"	120-277V 50/60 HZ	FPF265-4-2L-U-ENN
			60 Watt, Rapid Start, High Output T12 Recessed Double Contact 800mA Lamps, 48"	120-277V 50/60 HZ	FPF800-4-2L-U-ENN
			54 Watt, T5HO Miniature Bi-Pin Lamps, 48"	120-277V 50/60 HZ	FPFT5HO-4-2L-A-ENN FPFT5HO-4-2L-C-ENN
		Four Foot 3 Lamp Fixture	54 Watt, T5HO Miniature Bi-Pin Lamps, 48"	120-277V 50/60 HZ	FPFT5HO-4-3L-A-ENN FPFT5HO-4-3L-C-ENN
		Eight Foot 2 Lamp Fixture	59 Watt, Rapid Start, Slimline Single Pin, T8, 265mA Lamps, 96"	120-277V 50/60 HZ	FPF265-8-2L-U-ENN
		Eight Foot 4 Lamp Fixture	32 Watt, Instant Start, Medium Bi-Pin, T8 265mA Lamps, 48"	120-277V 50/60 HZ	FPF265-8-4L-U-ENN
	54 Watt, T5HO Miniature Bi-Pin Lamps, 48"		120-277V 50/60 HZ	FPFT5HO-8-4L-A-ENN FPFT5HO-4-3L-C-ENN	
	Switched <sup>②</sup>	Four Foot 2 Lamp Fixture	34 Watt, Rapid Start Medium Bi-Pin, T12 430mA Lamps, 48" (export only)	120-277V 50/60 HZ	FPF430-4-2L-U-ENS
			32 Watt, Instant Start, Medium Bi-Pin, T8 265mA Lamps, 48"	120-277V 50/60 HZ	FPF265-4-2L-U-ENS
			60 Watt, Rapid Start, High Output T12, Recessed Double Contact 800mA Lamps, 48"	120-277V 50/60 HZ	FPF800-4-2L-U-ENS
		Eight Foot 2 Lamp Fixture	59 Watt, Rapid Start, Slimline Single Pin, T8, 265mA Lamps, 96"	120-277V 50/60 HZ	FPF265-8-2L-U-ENS
		Eight Foot 4 Lamp Fixture	32 Watt, Instant Start, Medium Bi-Pin, T8 265mA Lamps, 96"	120-277V 50/60 HZ	FPF265-8-4L-U-ENS

① Non-Switched fixtures are furnished with stainless steel chain mount kit, non-metallic cord grip and 3 ft. long #16 AWG 3 conductor type SOA cable.

② Switched fixtures are furnished with stainless steel chain mount kit, non-metallic cord grip and 3 ft. long #16 AWG 4 conductor type SOA cable.

# FLUORESCENT FPF Series

Non-Metallic Housing • UL 1598 • CUL • Wet Locations • High Pressure Hose Down • Indoor or Outdoor • NSF Certified

## Coefficients of Utilization

### FPF226584L

% Effective Ceiling Cavity Reflectance rcc	80			50			10		
% Wall Reflectance rw	50	30	10	50	30	10	50	30	10
Room Cavity Ratio RCR	Effective Floor Cavity Reflectance 20%								
0	.67	.67	.67	.62	.62	.62	.56	.56	.56
1	.57	.55	.52	.53	.51	.50	.49	.47	.46
2	.50	.46	.42	.46	.43	.40	.42	.40	.38
3	.43	.39	.35	.41	.37	.34	.37	.34	.32
4	.38	.33	.29	.36	.32	.28	.33	.30	.27
5	.34	.29	.25	.32	.28	.24	.30	.26	.24
6	.31	.25	.22	.29	.24	.21	.27	.23	.21
7	.28	.23	.19	.26	.22	.19	.24	.21	.18
8	.25	.20	.17	.24	.20	.17	.22	.19	.16
9	.23	.18	.15	.22	.18	.15	.21	.17	.15
10	.21	.17	.14	.20	.16	.13	.19	.16	.13

## Candlepower Distribution

Deg.	Parl.	22.5	45	67.5	Norm
5	3076	3039	3045	3066	3101
15	2969	2943	2959	2991	3028
25	2744	2741	2789	2850	2893
35	2423	2453	2552	2658	2711
45	2007	2088	2253	2380	2428
55	1500	1654	1848	1980	1998
65	930	1170	1345	1446	1451
75	376	667	792	908	914
85	51	246	362	460	464
90	18	119	216	284	304

## Photometric Data

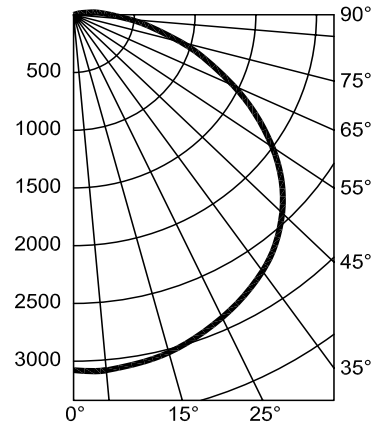

## Fixture Dimensions (inches)

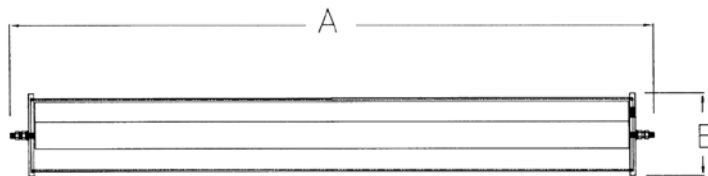

FPF SERIES	Dimensions (Inches)		Boxed Weight	Shipping Volume (Boxed Fixtures)
	A	B		
2 Foot Models	28.00	6.75	10 lbs.	1.2 cu. ft.
4 Foot Models	52.00	6.75	20 lbs.	2.1 cu. ft.
8 Foot Models	100.00	6.75	30 lbs.	4.0 cu. ft.

# FLUORESCENT FPF Series

Non-Metallic Housing • UL 1598 • CUL • Wet Locations • High Pressure Hose Down • Indoor or Outdoor • NSF Certified

## Accessories

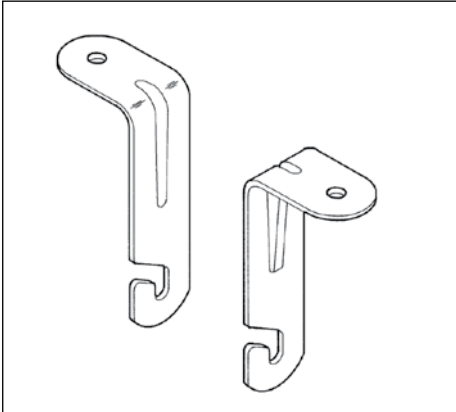

### Fixed Mounting Bracket Kit

Stainless Steel - For 3/8 in. Bolts (not provided)  
Catalog Number: FPFXDMKT  
Shipping Weight: 0.4 lbs.

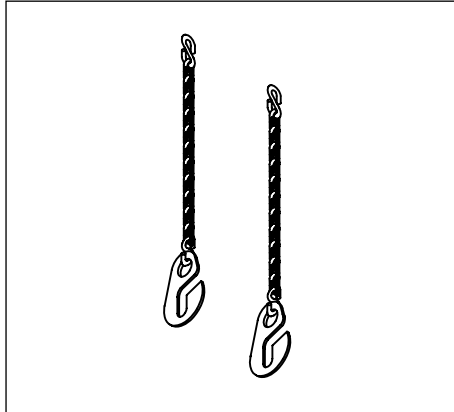

### Chain Mounting Kit

Stainless Steel  
Catalog Number: FPFCKMT1  
Shipping Weight: 0.2 lbs.



### Stainless Steel Band Clamp

Catalog Number: FPFBNDMKT  
Shipping Weight: 1.0 lbs.

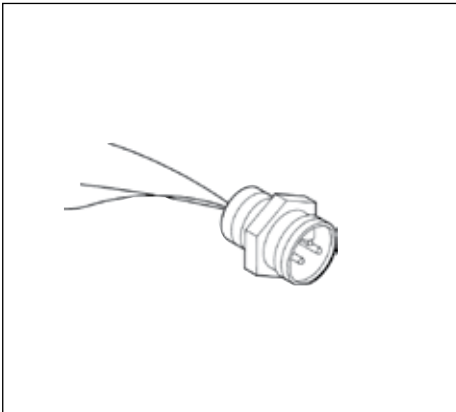

### Mini Receptacle 3P Male

Catalog Number: 64005  
Shipping Weight: 0.1 lbs.



### Pigtail Assembly- 3 ft. Cable

Other Lengths Available - Consult Factory  
Catalog Number: 53108  
Shipping Weight: 0.4 lbs.

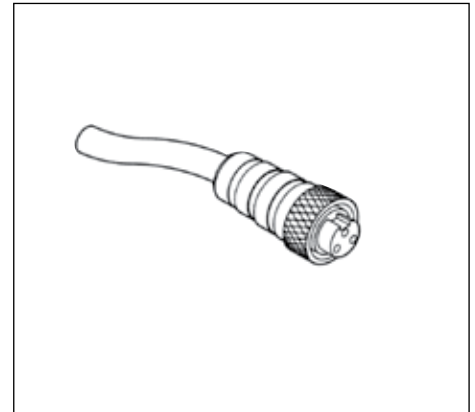

### Mini Plug 3P- 6 ft. Mini Cable

Other Lengths Available - Consult Factory  
Catalog Number: 60006  
Shipping Weight: 0.6 lbs.



### Polycarbonate Endcap Kit

Includes All Gaskets Glued in Place  
Catalog Number: 53101  
Shipping Weight: 3 lbs.



### Stainless Endcap Kit

Includes All Gaskets Glued in Place  
Catalog Number: 53101SS  
Shipping Weight: 2.5 lbs.